

1200V Silicon Carbide Schottky Diode

GENERAL DESCRIPTION

- ◆ 1200V Schottky rectifier
- ◆ Zero Forward/Reverse Recovery Current
- ◆ High Blocking Voltage
- ◆ High frequency operation
- ◆ Switching characteristics independent of temperature
- ◆ Positive temperature coefficient of forward voltage(VF)

BENEFIT

- ◆ Replace bipolar with unipolar rectifiers
- ◆ Essentially no switching losses
- ◆ higher efficiency
- ◆ Reduction of heat requirements
- ◆ Parallel devices without thermal runaway

Product Summary

- ◆ $V_R=1200V$
- ◆ $I_F=40A(TC=150^{\circ}C)$
- ◆ $Q_C=212nC(V_R=800V)$

Applications

- ◆ Motor Drives
- ◆ Solar / Wind Inverters
- ◆ Uninterruptable power supplies
- ◆ AC/DC converters
- ◆ DC/DC Converters

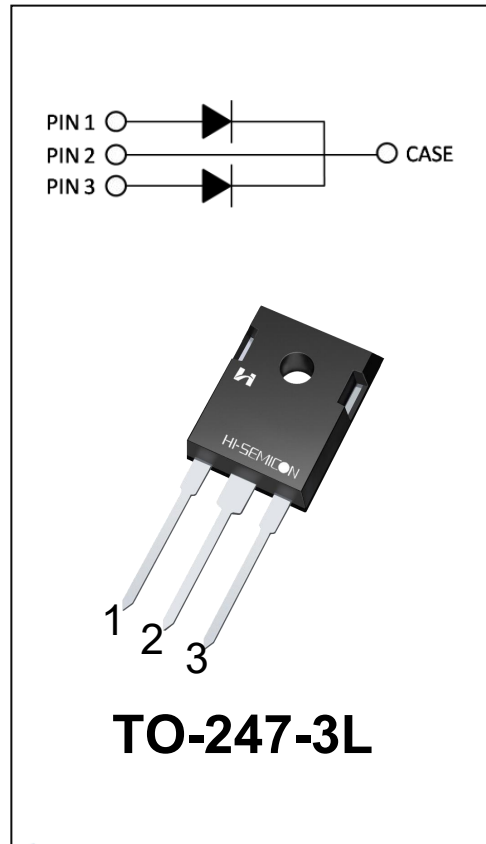

ORDERING INFORMATION

Part No.	Package	Marking	Material	Packing
SC3D40120D	TO-247-3L	C3D40120	Pb free	Tube

ABSOLUTE MAXIMUM RATINGS (T_J=25°C unless otherwise noted)

Characteristics		Symbol	Ratings		Unit
Repetitive peak reverse voltage		V _{RRM}	1200		V
Maximum DC blocking voltage		V _R	1200		V
Surge peak reverse voltage		V _{RSM}	1200		V
Continuous forward current (per leg / per device)	T _C =25°C	I _F	55	110	A
	T _C =135°C		24	48	
	T _C =150°C		20	40	
Repetitive peak forward surge current	tp=10ms T _C =25°C	I _{FRM}	140		A
	tp=10ms T _C =110°C		130		
Non-repetitive peak forward surge current	tp=10ms T _C =25°C	I _{FSM}	110		A
	tp=10ms T _C =110°C		100		
Power dissipation (per leg / per device)	T _C =25°C	P _{tot}	250	429	W
	T _C =110°C		108	186	
Diode dv/dt ruggedness	VR = 0-1200V	dv/dt	80		V/ns
Operating junction temperature		T _J	-55~175		°C
Storage temperature range		T _{stg}	-55~175		
Maximum lead temperature for soldering purposes, 1/8" from case for 5 seconds		TL	300		°C

ELECTRICAL CHARACTERISTICS

Characteristics	Symbol	Test conditions	Min.	Typ.	Max.	Unit
DC Blocking Voltage	VDC	T _J =25°C	1200	--	--	V
Forward voltage drop	V _F	I _F =20A, T _J =25°C	--	1.45	1.8	V
		I _F =20A, T _J =125°C	--	1.8	--	
		I _F =20A, T _J =175°C	--	2.0	--	
Reverse leakage current	I _R	V _R =1200V, T _J =25°C	--	10	200	uA
		V _R =1200V, T _J =125°C	--	20	--	
		V _R =1200V, T _J =175°C	--	50	--	
Total capacitance	C	V _R =1V, f=1MHz	--	1190	--	pF
		V _R =400V, f=1MHz	--	101	--	
		V _R =800V, f=1MHz	--	72	--	
Total capacitance charge	Q _C	V _R =800V, T _J =25°C	--	106	--	nC

THERMAL CHARACTERISTICS

Characteristics	Symbol	Typ.	Unit
Thermal Resistance, Junction-to-Case	R _{θJC}	0.35	°C/W

Typical Performance Characteristics

Figure.1: Forward characteristics

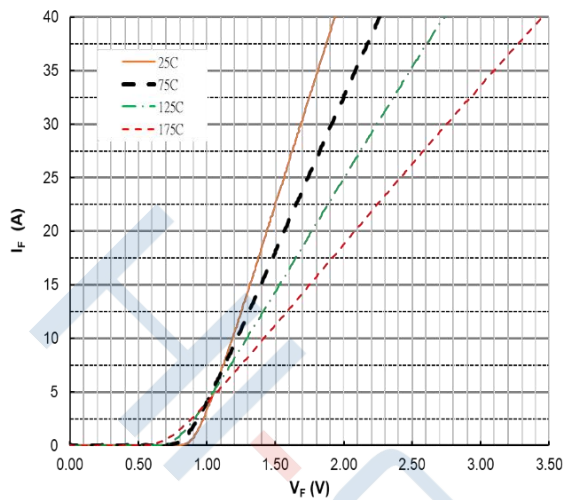

Figure.2: Forward Characteristics

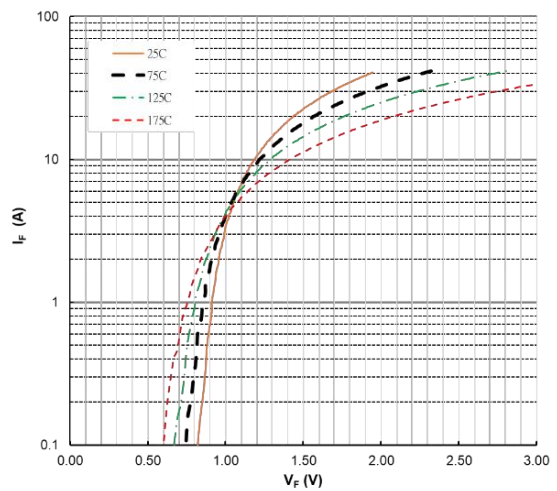

Figure.3: Reverse Characteristics

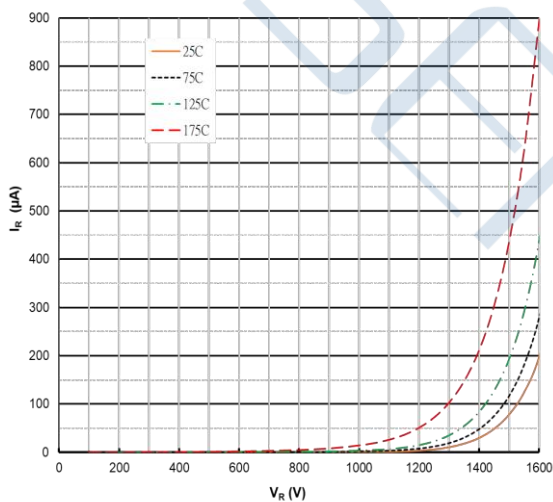

Figure.4: Power Derating

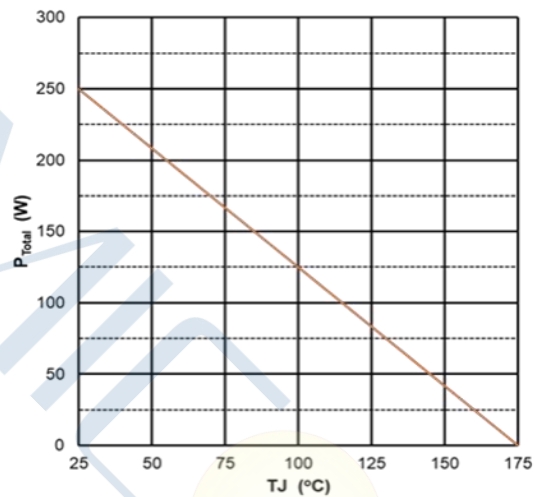

Figure.5: Reversecharge vs. Reverse Voltage

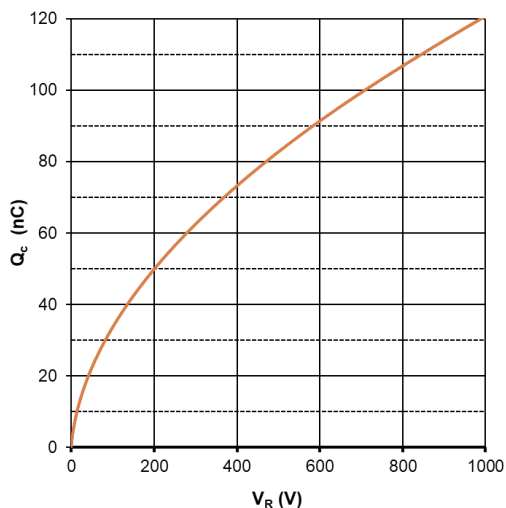
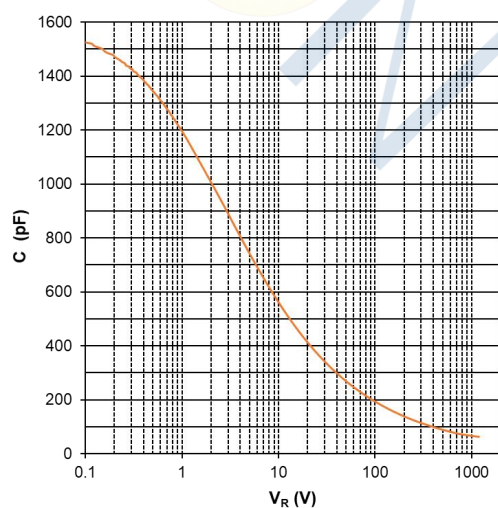
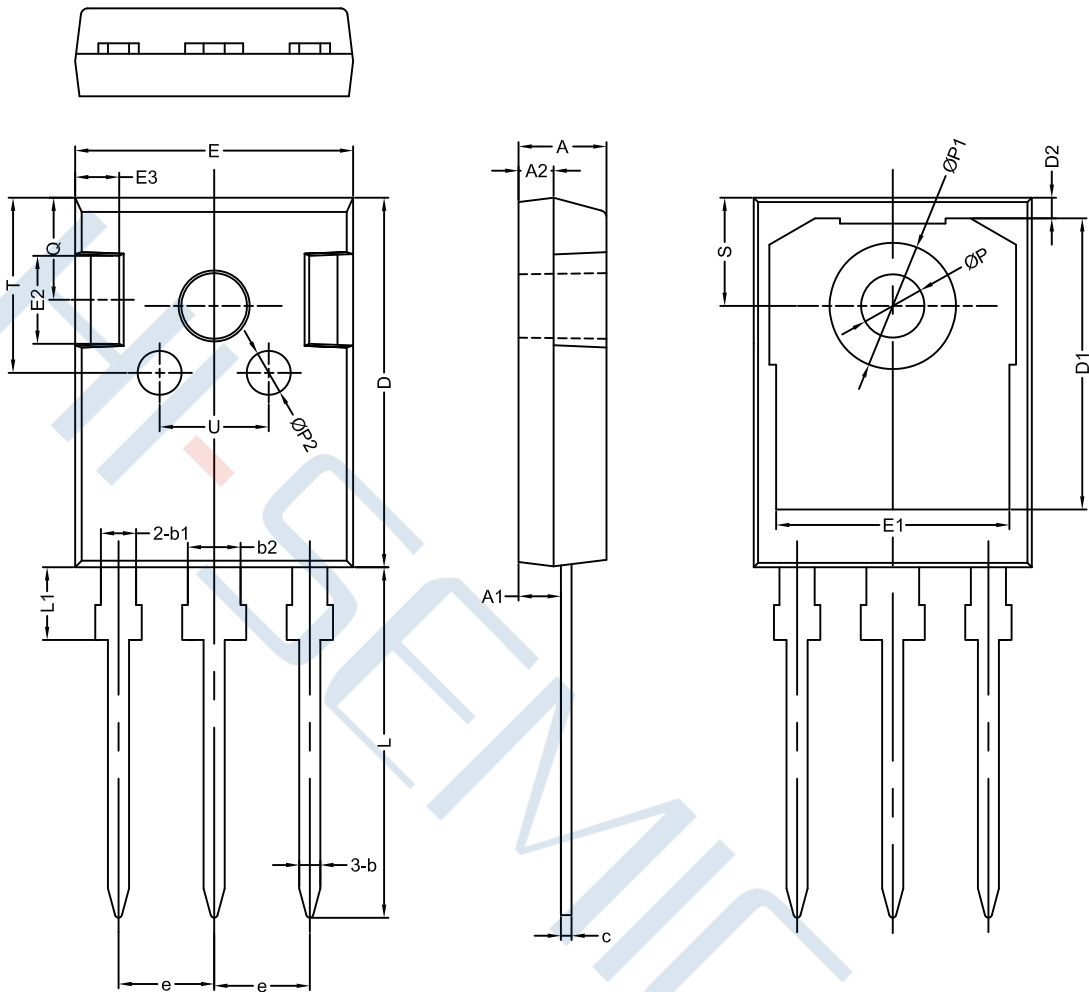

Figure.6: Capacitance vs. Reverse Voltage



Package Dimensions of TO-274-3L



符号	机械尺寸/mm		
	最小值	典型值	最大值
A	4.80	5.00	5.20
A1	2.21	2.41	2.61
A2	1.90	2.00	2.10
b	1.10	1.20	1.35
b1		2.00	
b2		3.00	
c	0.55	0.60	0.75
D	20.80	21.00	21.20
D1		16.55	
D2		1.20	
E	15.60	15.80	16.0
E1		13.30	
E2		5.00	
E3		2.50	
e		5.44	
L	19.42	19.92	20.42
L1		4.13	
P	3.50	3.60	3.70
P1		7.19	
P2		2.50	
Q		5.80	
S	6.05	6.15	6.25
T		10.00	
U		6.20	

Disclaimer:

- ▶ Hi-semicon reserves the right to make changes to the information herein for the improvement of the design and performance without further notice! Customers should obtain the latest relevant information before placing orders and should verify that such information is complete and current.
- ▶ All semiconductor products malfunction or fail with some probability under special conditions. When using Hi-semicon products in system design or complete machine manufacturing, it is the responsibility of the buyer to comply with the safety standards strictly and take essential measures to avoid situations in which a malfunction or failure of such Hi-semicon products could cause loss of body injury or damage to property.
- ▶ Hi-semicon will supply the best possible product for customers!