

**40V, 30A DUAL N CHANNEL POWER MOSFET**

**GENERAL DESCRIPTION**

The SFM0430T2 uses advanced trench technology and design to provide excellent  $R_{DS(on)}$  with low gate charge. It can be used in a wide variety applications.

**Features**

- ◆  $V_{DS}=40V, I_D=30A$
- ◆  $R_{DS(on)}$   
TYP:  $11.3m\Omega @ V_{GS}=10V$

**Applications**

- ◆ Power faction correction (PFC)
- ◆ Switched mode power supplies (SMPS)
- ◆ Uninterruptible power supply (UPS)
- ◆ LED lighting power

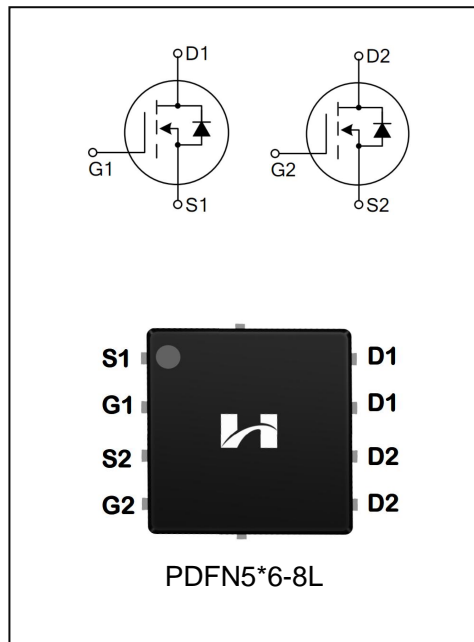

**ORDERING INFORMATION**

Part No.	Package	Marking	Material	Packing
SFM0430T2	PDFN5*6	SFM0430T2	Pb Free	Reel

## ABSOLUTE MAXIMUM RATINGS (T<sub>J</sub>=25°C unless otherwise noted)

Characteristics		Symbol	Ratings	Unit
Drain-Source Voltage		V <sub>DS</sub>	40	V
Gate-Source Voltage		V <sub>GS</sub>	±20	V
Drain Current	T <sub>C</sub> = 25°C	I <sub>D</sub>	30	A
	T <sub>C</sub> = 100°C		21	
Drain Current Pulsed(Note 1)		I <sub>DM</sub>	120	A
Power Dissipation(T <sub>C</sub> =25°C) -Derate above 25°C		P <sub>D</sub>	52	W
			1.3	W/°C
Single Pulsed Avalanche Energy (Note 2)		E <sub>AS</sub>	72	mJ
Operation Junction Temperature Range		T <sub>J</sub>	-55~+150	°C
Storage Temperature Range		T <sub>stg</sub>	-55~+150	
Maximum lead temperature for soldering purposes, 1/8" from case for 5 seconds		TL	300	

## THERMAL CHARACTERISTICS

Characteristics	Symbol	MAX	Unit
Thermal Resistance, Junction-to-Case	R <sub>θJC</sub>	2.1	°C/W
Thermal Resistance, Junction-to-Ambient	R <sub>θJA</sub>	68	

## ELECTRICAL CHARACTERISTICS

Characteristics	Symbol	Test conditions	Min.	Typ.	Max.	Unit
Off Characteristics						
Drain -Source Breakdown Voltage	B <sub>VDS</sub>	V <sub>GS</sub> =0V, I <sub>D</sub> =250μA	40	--	--	V
Drain-Source Leakage Current	I <sub>DSS</sub>	V <sub>DS</sub> =40V, V <sub>GS</sub> =0V	--	--	1	uA
Gate-Source Leakage Current	I <sub>GSS</sub>	V <sub>GS</sub> =20V, V <sub>DS</sub> =0V	--	--	100	nA
Gate-Source Leakage Current	I <sub>GSS</sub>	V <sub>GS</sub> =-20V, V <sub>DS</sub> =0V	--	--	-100	
On Characteristics						
Gate Threshold Voltage	V <sub>GS(th)</sub>	V <sub>GS</sub> = V <sub>DS</sub> , I <sub>D</sub> =250μA	1.0	1.5	1.8	V
Static Drain- Source On State Resistance	R <sub>DS(on)</sub>	V <sub>GS</sub> =10V, I <sub>D</sub> =15A	--	11.3	16	mΩ
		V <sub>GS</sub> =4.5V, I <sub>D</sub> =5A	--	14.2	20	
Dynamic Characteristics						
Gate Resistance	R <sub>g</sub>	V <sub>GS</sub> =0V, f=1.0MHZ	1	5	10	Ω
Input Capacitance	C <sub>iss</sub>	V <sub>DS</sub> =20V V <sub>GS</sub> =0V f=1.0MHZ	--	1135	--	pF
Output Capacitance	C <sub>oss</sub>		--	105	--	
Reverse Transfer Capacitance	C <sub>rss</sub>		--	86.5	--	
Switching Characteristics						
Turn-on Delay Time	t <sub>d(on)</sub>	V <sub>DD</sub> =20V, V <sub>GS</sub> =10V R <sub>GS</sub> =3.3Ω, I <sub>D</sub> =15A (Note 3.4)	--	8.1	--	ns
Turn-on Rise Time	t <sub>r</sub>		--	23.7	--	
Turn-off Delay Time	t <sub>d(off)</sub>		--	35.1	--	
Turn-off Fall Time	t <sub>f</sub>		--	16.2	--	

Total Gate Charge	$Q_g$	$V_{DS}=20V, I_D=15A$ $V_{GS}=10V$ (Note 3.4)	--	23.3	--	nc
Gate-Source Charge	$Q_{gs}$		--	7.5	--	
Gate-Drain Charge	$Q_{gd}$		--	12.1	--	

### SOURCE-DRAIN DIODE RATINGS AND CHARACTERISTICS

Characteristics	Symbol	Test conditions	Min.	Typ.	Max.	Unit
Continuous Source Current	$I_S$	Integral Reverse P-N Junction Diode in the MOSFET	--	--	30	A
Pulsed Source Current	$I_{SM}$		--	--	120	
Diode Forward Voltage	$V_{SD}$	$I_S=15A, V_{GS}=0V$	--	0.8	1.2	V

1. Pulse width limited by maximum junction temperature
2.  $L=0.5mH, V_{DD}=20V, V_G=10V, R_G=25, \text{ starting } T_J=25\text{ }^\circ\text{C}$
3. Pulse Test: Pulse width  $\leq 300\mu s$ , Duty cycle  $\leq 2\%$
4. Essentially independent of operating temperature

Typical Performance Characteristics

Figure 1. Output Characteristics

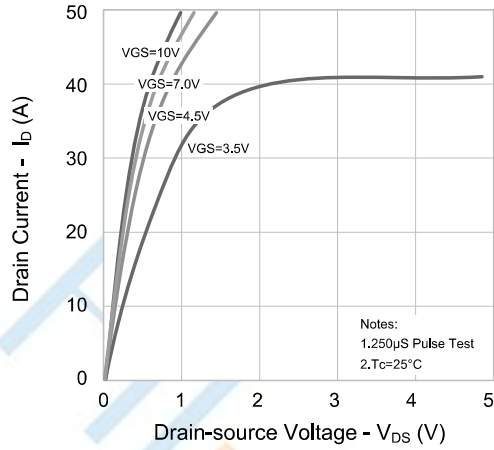

Figure 2. Transfer Characteristics

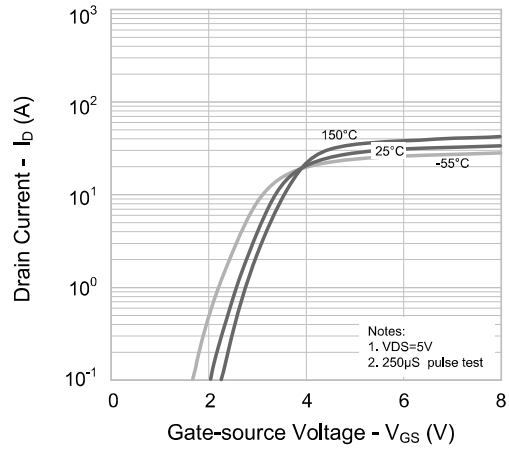

Figure 3. On-resistance vs. Drain Current

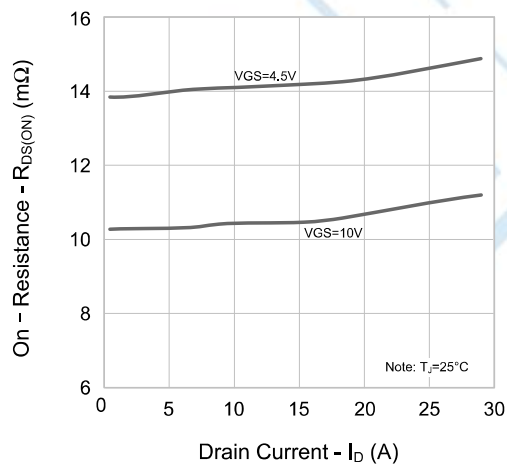

Figure 4. Body Diode Forward Voltage Variation vs. Source Current and Temperature

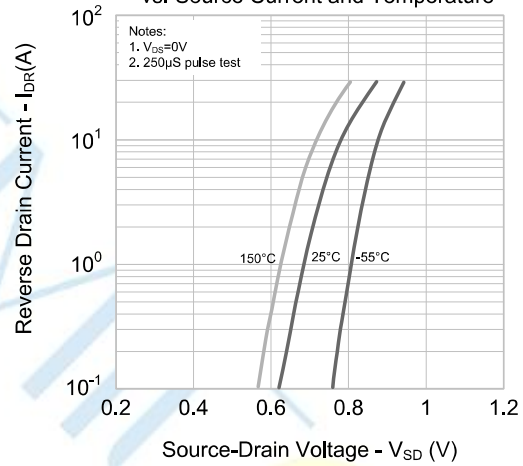

Figure 5. Capacitance Characteristics

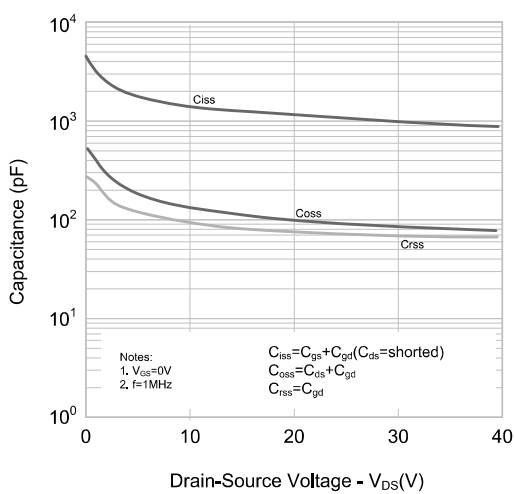
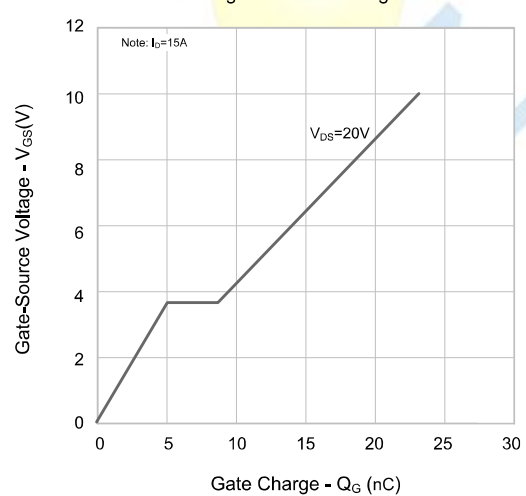
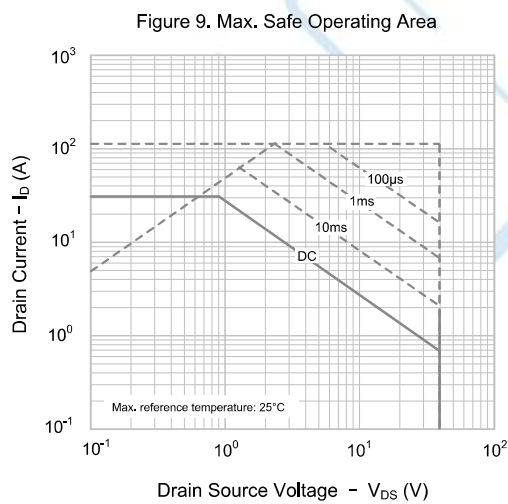
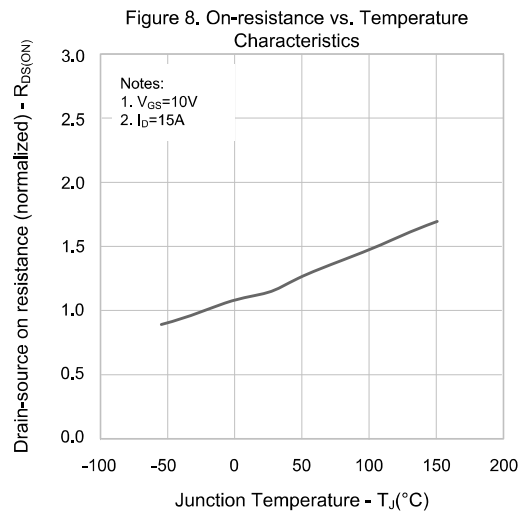
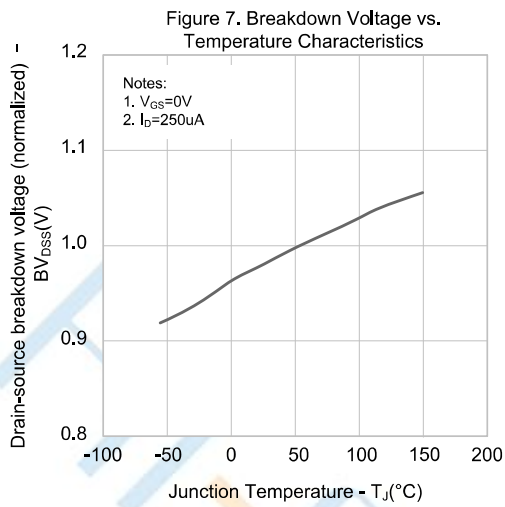

Figure 6. Gate Charge



Typical Performance Characteristics



Test Circuit

Gate Charge Test Circuit & Waveform

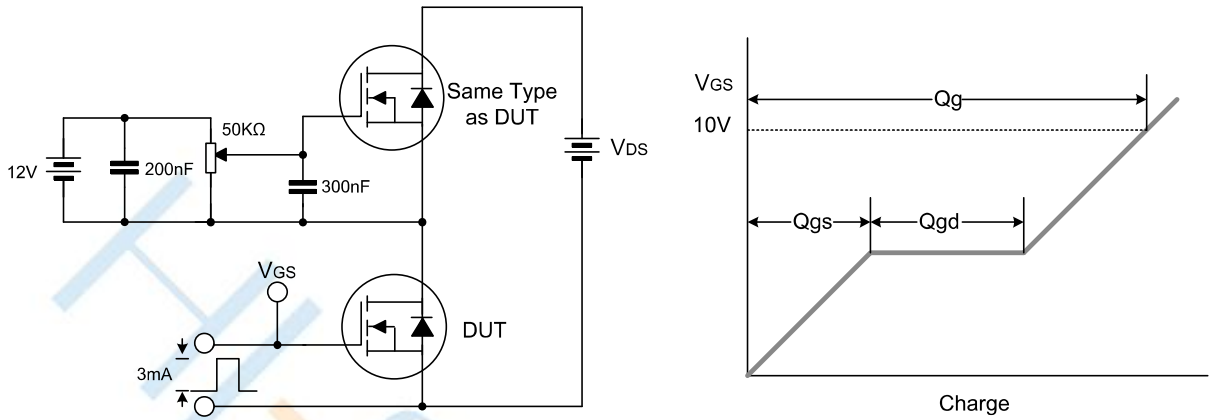

Resistive Switching Test Circuit & Waveform

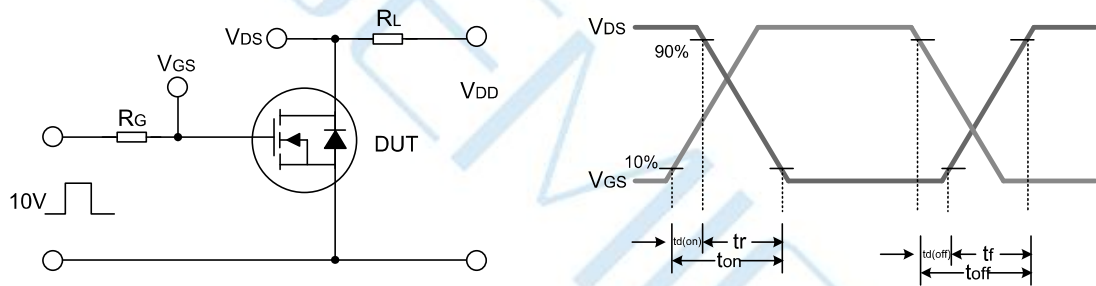

Undamped Inductive Switching Test Circuit & Waveform

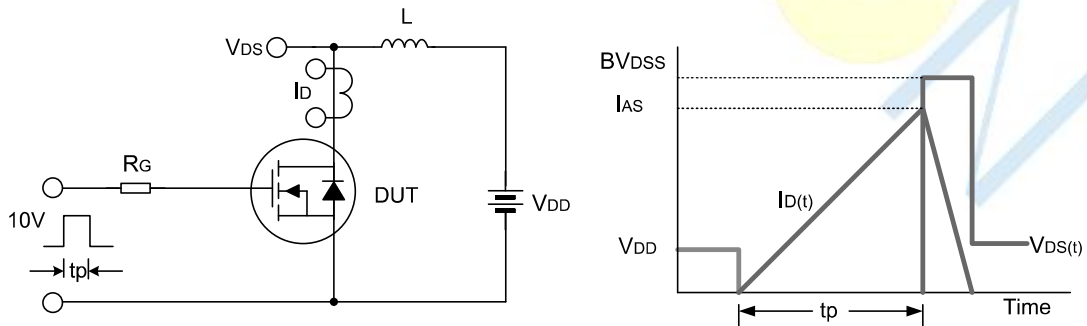

Package Dimensions of PDFN5\*6-8L

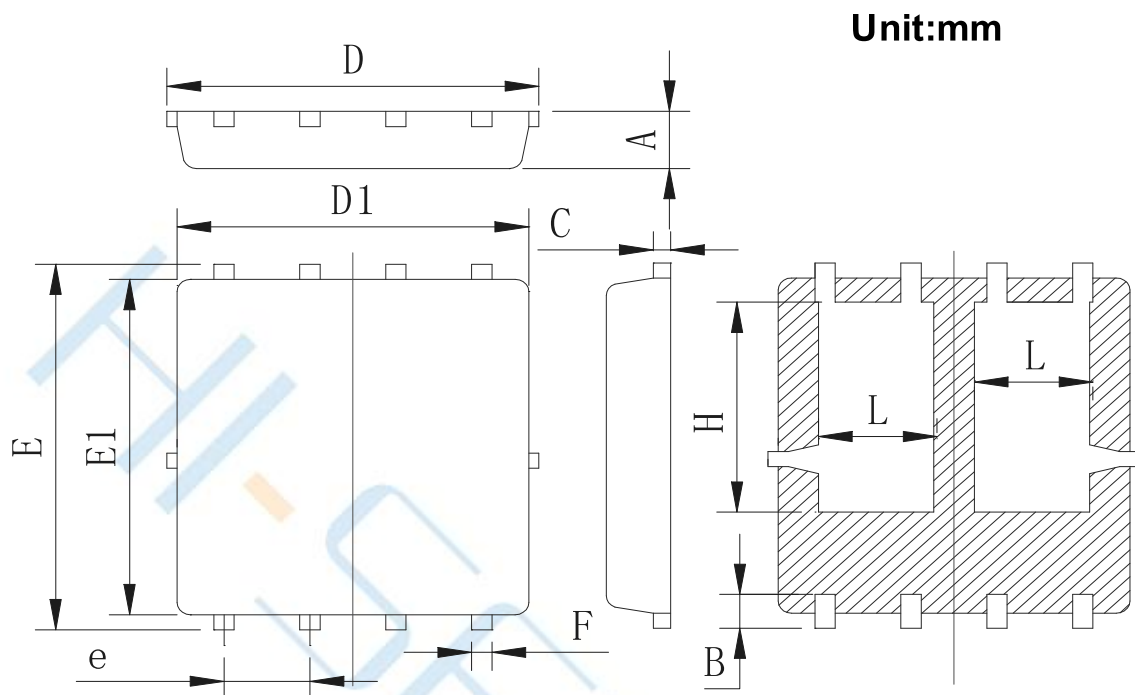

Symbol	Min	Typ	Max
A	0.90	0.95	1.00
B	0.48	0.58	0.68
C	0.234	0.254	0.282
D	5.40	5.50	5.60
D1	5.10	5.20	5.30
E	5.95	6.05	6.15
E1	5.45	5.55	5.65
e	1.22	1.27	1.32
F	0.25	0.30	0.35
H	3.37	3.47	3.57
L	1.60	1.70	1.80

**Disclaimer:**

- ▶ Hi-semicon reserves the right to make changes to the information herein for the improvement of the design and performance without further notice! Customers should obtain the latest relevant information before placing orders and should verify that such information is complete and current.
- ▶ All semiconductor products malfunction or fail with some probability under special conditions. When using Hi-semicon products in system design or complete machine manufacturing, it is the responsibility of the buyer to comply with the safety standards strictly and take essential measures to avoid situations in which a malfunction or failure of such Hi-semicon products could cause loss of body injury or damage to property.
- ▶ Hi-semicon will supply the best possible product for customers!